

# Электроэрозионный станок

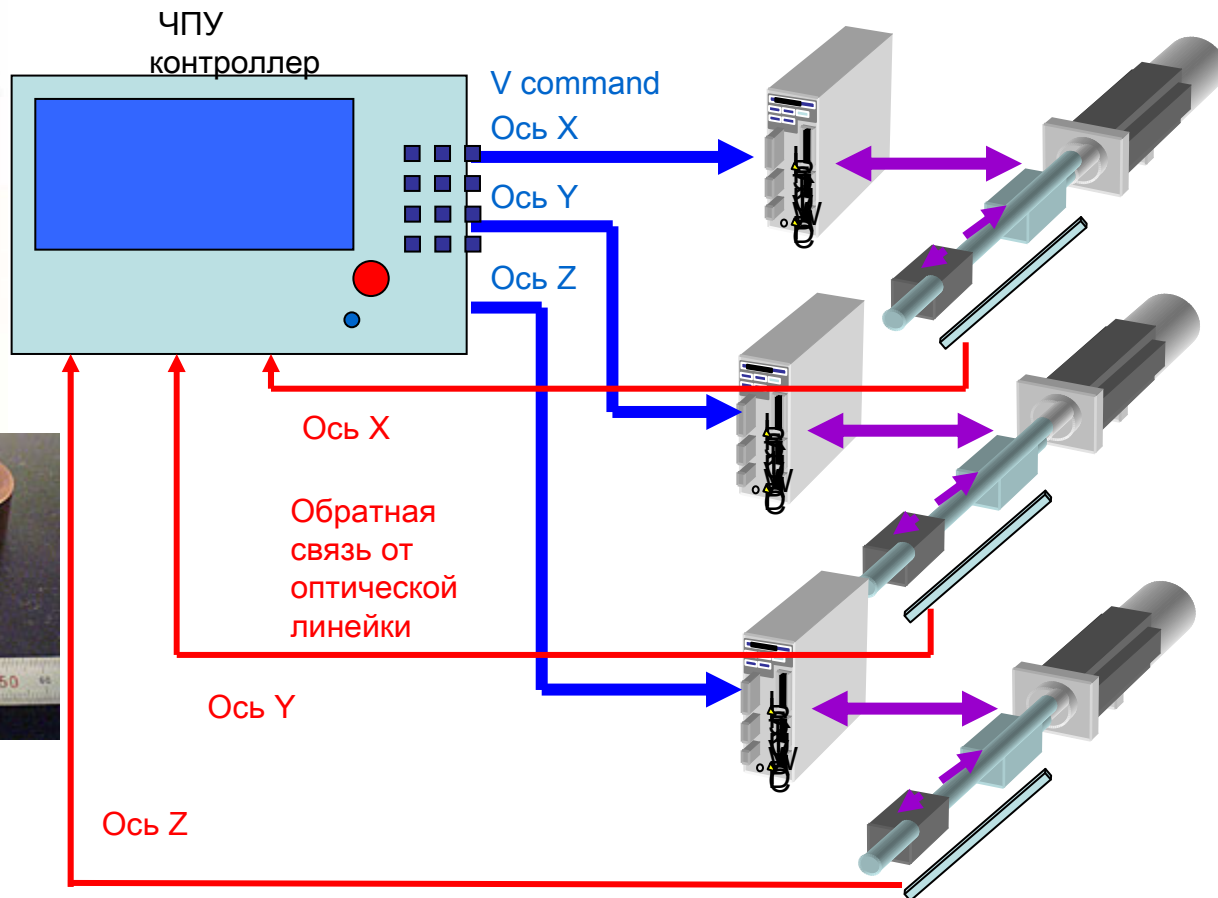

# Гравировальный станок

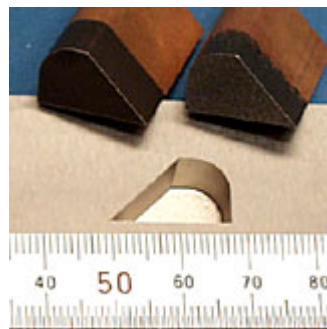
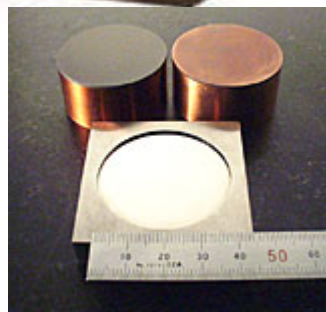
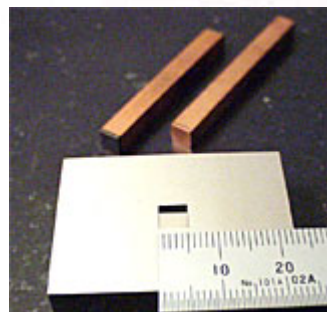
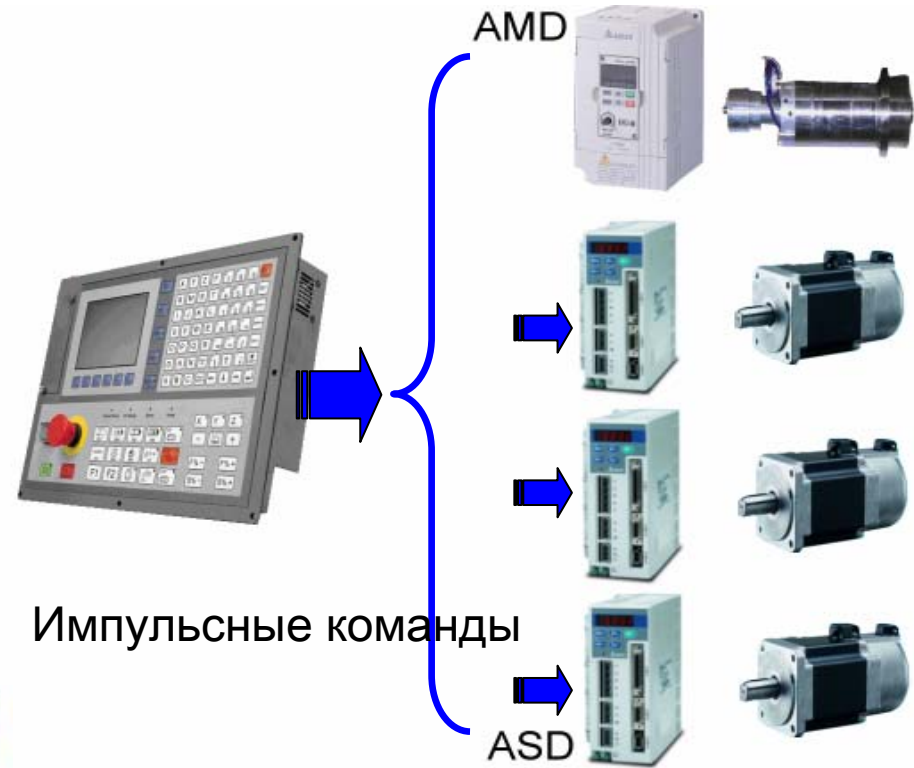
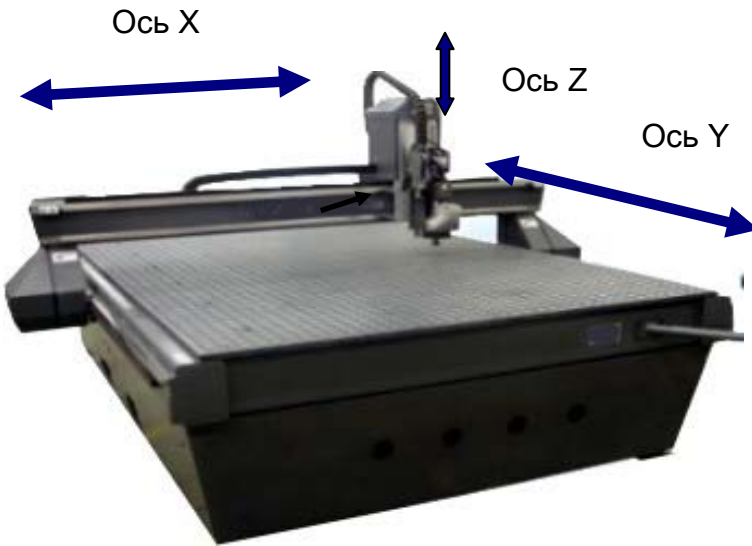

# Автоматический загрузчик заготовок

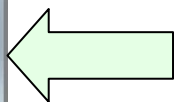
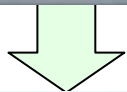

Задание скорости сервомотора по MODBUS с энкодером, подключённым ко входу PLC в цепи обратной связи по положению.

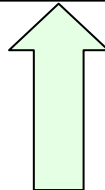

Управление сервоприводом по протоколу Easy Link от PLC

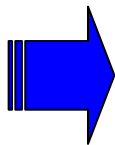
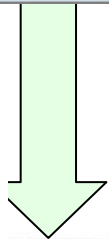

# Токарный станок с ЧПУ



# Линия контроля DVD

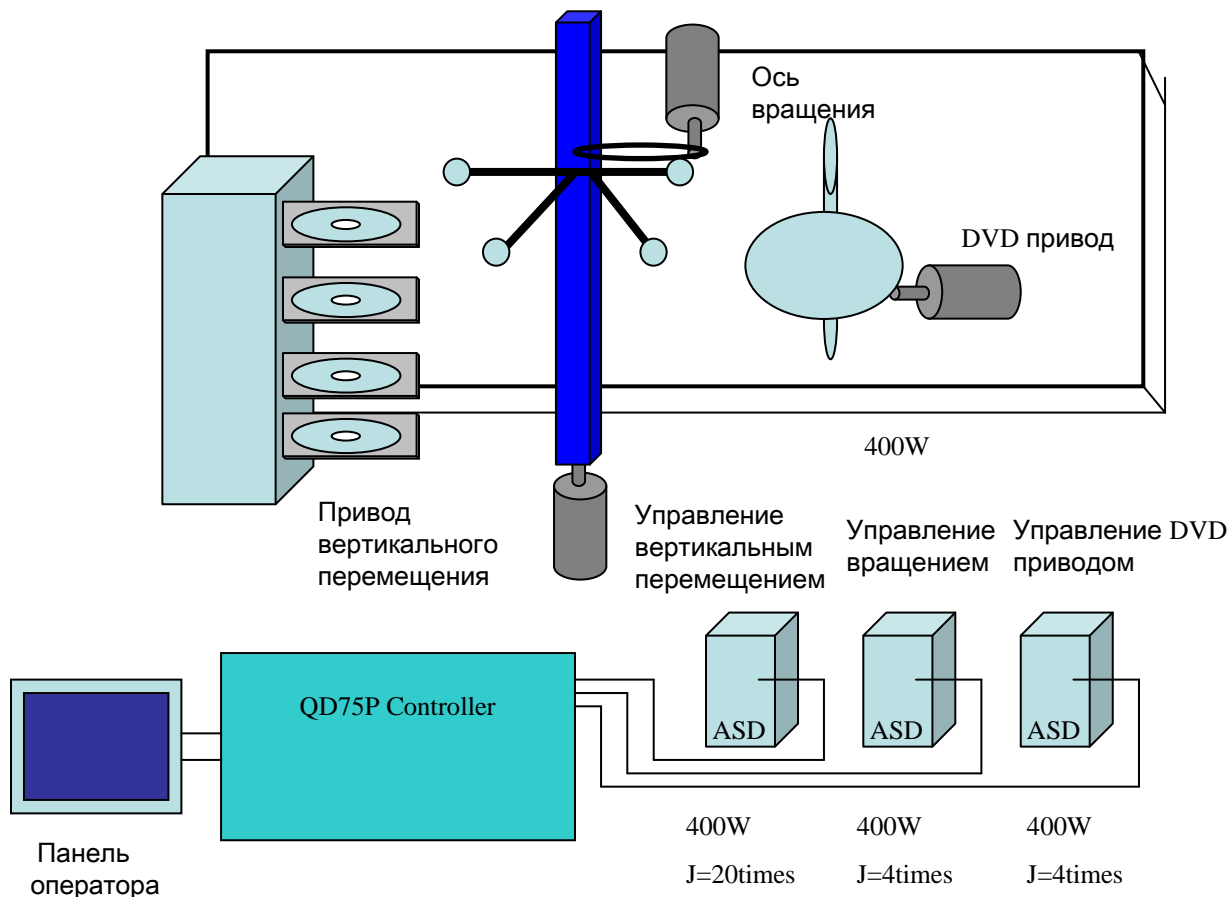

# Станок лазерной резки

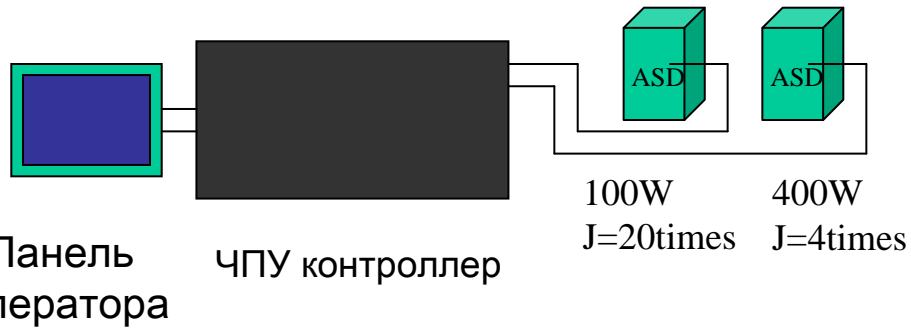
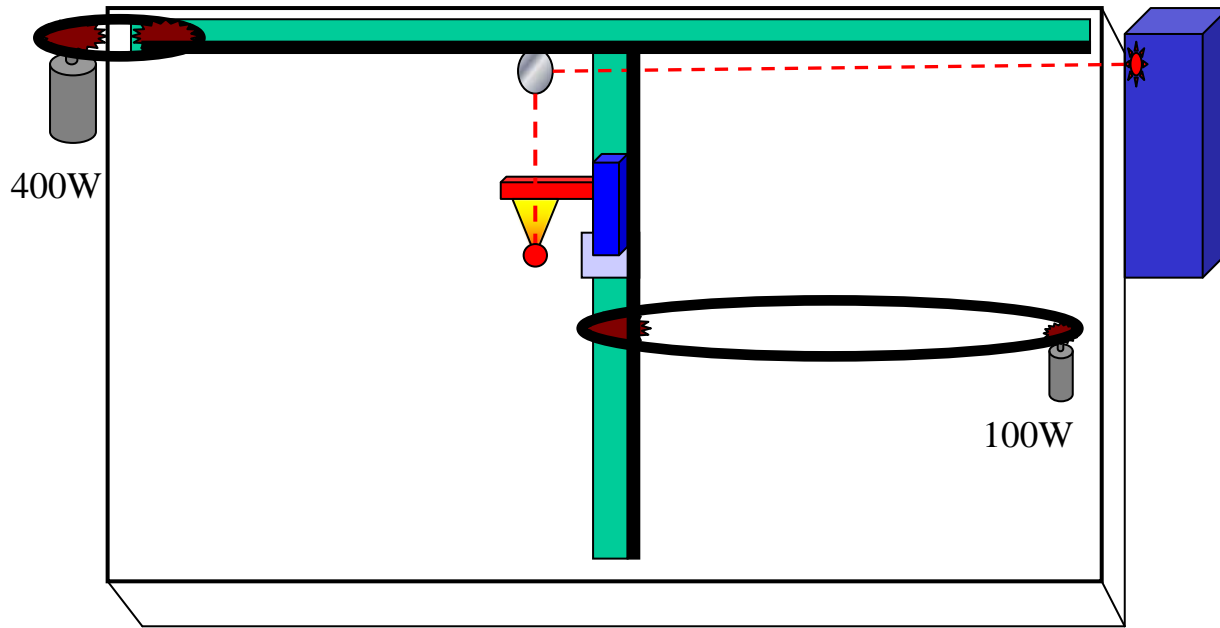

# Бобинорезка

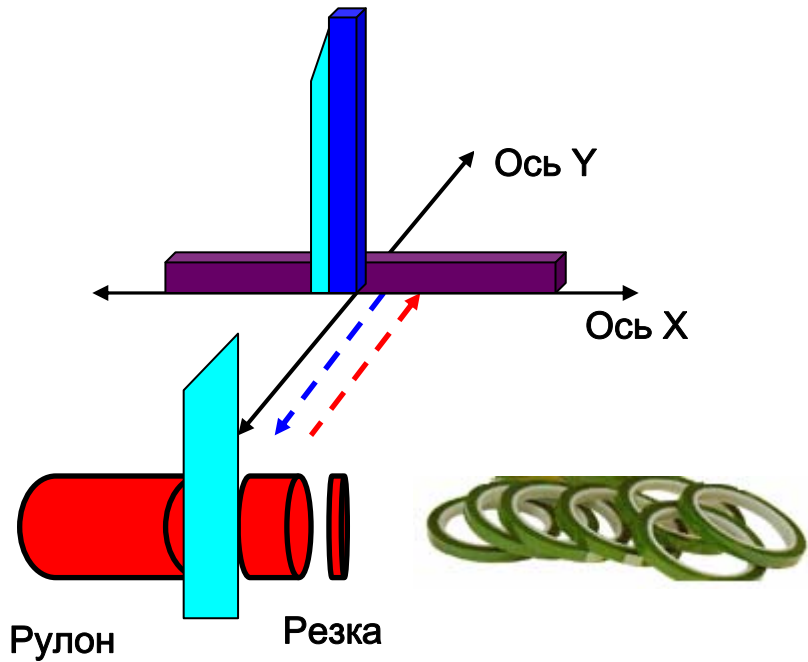

HMI



PLC

AMD



ASD



# Намоточный станок

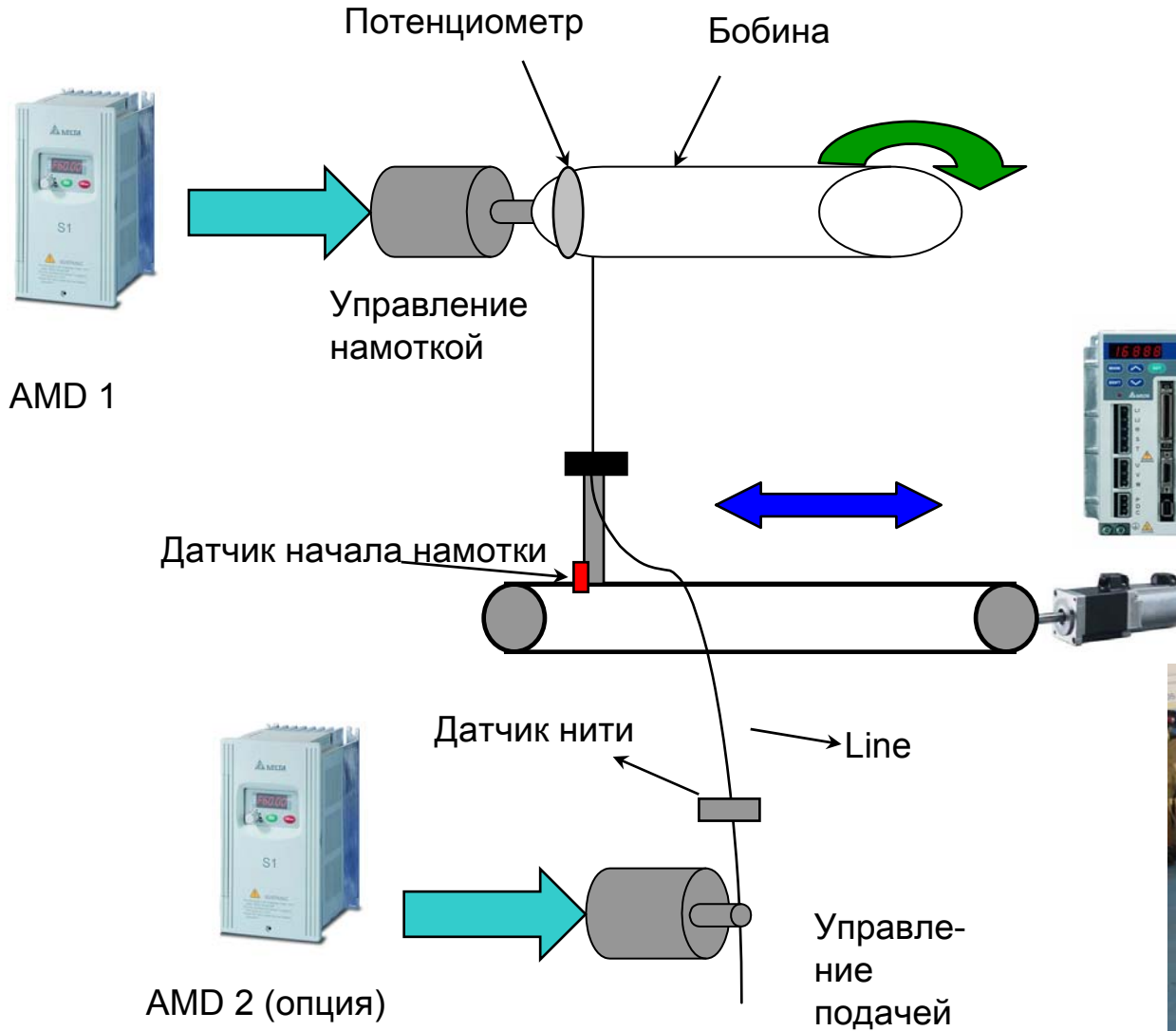



# Линия контроля микросхем

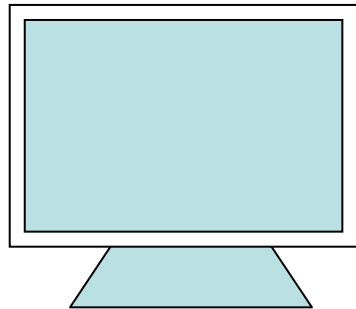

Компьютер

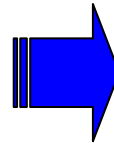
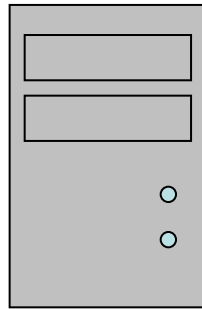

~~Контроллер перемещения~~



Видеокарта

Импульсы

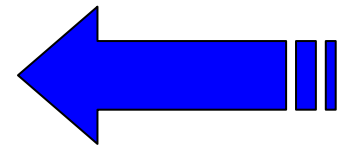

OZ signal

